

Laschenverbinder, Winkelverbinder, Laschenanker
 für Holzkonstruktionen
Timber connectors



* **LIEBIG-Dübel** ---> Seite 68
LIEBIG fixings ---> pages 68



L-Haken, Rohrhaken
L-bolts, stirrup bolts



* **LINDAPTER-Klemmelemente** ---> Seite 62
LINDAPTER bolts adapters, flange clamps ---> page 62



Luftschicht-Verblend-/Sanier-Anker
Wall anchors



Messing-Spreizdübel
Brass plugs



Montage-/Abhänge-Band
Perforated straps hangers



Rohr-Befestigungen, Rohr-Lager
 Rohr-Abhängungen (fest/gedämmt)
Pipe fixings

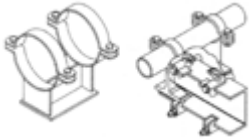

Schienen-Befestigungs-Systeme
Rail fixings



* **Schweiß-Kopfbolzen, Maueranker, Plattenanker**
 (NELSON-Kopfbolzen)
Foundation anchors



Schrägzug-Spannelemente/-Anker
 für Windverbände
 Kurvenstücke für Schrägzug bis 45°
Angular tensile joints and anchors



Schraubtechnik ---> Seite 69
Fastening technique ---> page 69



Seilspanner, Wantenspanner
Turnbuckles



Artikel-Nr.	Material	Überzug
	Stahl NiroStahl A4	galZn feuerZn
	Stahl NiroStahl A2, A4	galZn feuerZn
82001-82058	Temperguß GT Stahl NiroStahl A2, A4	galZn (feuerZn)
	NiroStahl A4	
88910	Messing	
	Stahl	galZn lackiert
	Stahl/ Temperguß NiroStahl A2,A4	galZn feuerZn
	Stahl Temperguß	galZn feuerZn
	Stahl NiroStahl A2, A4	galZn
	Stahl 52 geschmiedet Stahl	galZn feuerZn brün
	Stahl NiroStahl A4	galZn

* mit bauaufsichtlicher Zulassung des DIfBT (Deutsches Institut für Bautechnik, Berlin)



Spannstäbe und Wellenanker für den Betonbau
 Wirbelmutter für Spannstäbe
 Stahlkone für Spannstäbe
 Verbindungsmutter mit Wassersperre
Tension rods, wing-nuts for tension rods
Cones for tension rods, water blocking nuts for tension rods

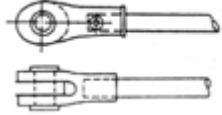

Stabanker für Stahlkonstruktionen:
 Gabelköpfe, Rechts-/Links-Gewinde
 Bolzen, Zugstäbe
Anchor-systems for steel constructions



Transportanker, Kugelkopfanke
Lifting ball head anchors



TOX-Dübel 4 AS, 4 AS K
 TOX-Allzweckdübel Tri, Trika
TOX-wall plugs



* **Upat-Dübel** ---> Seite 66
Upat fixings ---> page 66



Unterlagsplatten, Ankerplatten, Rippenplatten
Anchor sheets, heavy duty washers



Verbindungsmuffen, Reduzierstücke
 sechskantig, rund
Couplings

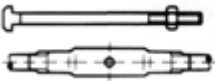

Zuganker
Tractive anchors

Klemmelemente

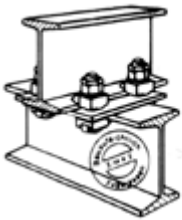

Das Verbindungs- und Klemmsystem mit überraschend vielen Vorteilen für Neubau und Nachrüstung:
 • variabel klemmen statt schweißen und bohren
 • unbegrenzt einsetzbar in jeder Konstruktion
 • einfach, schnell und sicher in der Montage
 • kosten- und zeitsparender Einsatz.
 Wer einmal "Lindapter" findet immer mehr Einsatzmöglichkeiten - immer mehr Gelegenheiten, unnötige Kosten einzusparen.

LINDAPTER-Klemm-Elemente
LINDAPTER bolt adapters



* Typ A, B



Typ BS, D2, (D3)



Typ C 1, C 2



Typ E, LR

Artikel-Nr.	Material	Überzug
	Stahl Stahl Stahl	galZn galZn
	Sphäroguß Stahl	galZn feuerZn
	Stahl 52-3	
88380 88383	Kunststoff Kunststoff	
	Stahl NiroStahl A2, A4	galZn feuerZn
88087- 88089	Stahl NiroStahl A2, A4	galZn feuerZn
	Stahl NiroStahl A2, A4	galZn feuerZn
82001 82002	Temperguß	galZn (feuerZn)
82003 82007	Temperguß	galZn (feuerZn)
82004 82005	Temperguß	galZn (feuerZn)
82006 82010	Temperguß	galZn (feuerZn)

* mit bauaufsichtlicher Zulassung des DIFBT (Deutsches Institut für Bautechnik, Berlin)

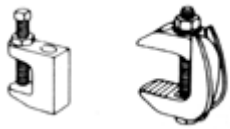

LINDAPTER-Klemmen
 Typ FL, F3, F9, LC
LINDAPTER flange clamps



Scheiben und Distanzstücke für
 LINDAPTER-Klemmelemente
Washers, tips and packings for LINDAPTER bolt adapters

* Typ CW, P

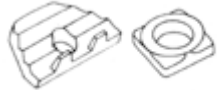

* Typ T, W

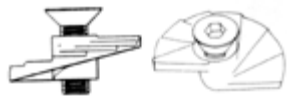

LINDAPTER-FLOOR-FAST Typ FF
 Bodenplatten-Befestigungen
LINDAPTER-FLOOR-FAST, floor fixings



LINDAPTER-HOLLO-FAST Typ HF
 LINDAPTER-HOLLO-BOLT Typ HB
 Blindmontagebefestigungen für Stahlhohlprofile
LINDAPTER-HOLLO-FAST/HOLLO-BOLT steel cavity fixings



LINDAPTER-Abhängemutter Typ VN
 für V-Nut-Profile
LINDAPTER-V-nut



LINDAPTER-KIPP-PLATTEN Typ TC
 mit Innengewinde
LINDAPTER-Toggle-clamps

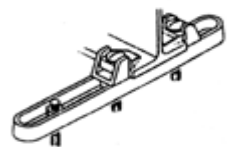

LINDAPTER - Gang Hanger Typ GH
 Montageset anbaufertig
LINDAPTER fixing sets

Dübel und Anker



FISCHER-Dübel: Allgemeine Befestigungen
FISCHER fixings: General fixings



FISCHER-Dübel S
FISCHER wall plugs

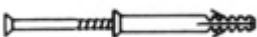

FISCHER-Nageldübel N, N-AZ, N-FZ, N-FAL,
 N-FN/N-FC, N 6x40 M6
FISCHER nail plugs (Hammerfix)

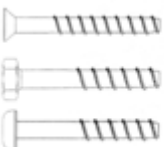

FISCHER-Direktmontage-Schraube FDS
 mit Flachskenk-(F)-/Sechskant-(S)-/
 Panhead-(P)-Kopf
FISCHER fixing screws

* mit bauaufsichtlicher Zulassung des DIfBT (Deutsches Institut für Bautechnik, Berlin)

Artikel-Nr.	Material	Überzug
82008 82009 82022 82025 82058	Temperguß	galZn (feuerZn)
82011 82012- 82017	Stahl Temperguß	galZn (feuerZn)
82018 82021	Temperguß	galZn (feuerZn)
82019	Temperguß (Schraube DIN 7991)	galZn
82020 82031	Temperguß	galZn
82023	Temperguß	galZn
82024	Temperguß	galZn
82030	Temperguß (Schrauben 4,6 Muttern 5)	galZn galZn galZn
88500	Kunststoff	
88503	Kunststoff/ Schraube: Stahl NiroStahl A2	galZn
88560 88561 88562	Stahl gehärtet	



FISCHER-Dübel M-S
FISCHER wall plugs



FISCHER-Dübel M
FISCHER wall plugs



FISCHER-Messingdübel PA 4
FISCHER board anchors



* FISCHER-Universaldübel FU, FU-D, FU-H, * FU-R, FU-S
 FISCHER-Allrounddübel UV, UV-R
FISCHER wall plugs



FISCHER-Schellen SCH, FC
FISCHER nylon saddles (clamps)

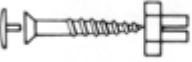

FISCHER-Balkonbefestigungen BBF, P9K,
 Treppenbefestigungen TB, TBB.
FISCHER special fixings for balcony and stairs



FISCHER-Sanitär-Befestigungen WD, WST, UST, BO,
 WL, WCN, S8 RD WCR, S14W, ST-S
FISCHER sanitary fixing sets



FISCHER-Bundmuttern BUM
 FISCHER-Abdeck-Kappen AKM
FISCHER capsules
FISCHER cap



FISCHER-Türstopper TS8
FISCHER door stops



FISCHER-Dübel: Hohlraum-Befestigungen
FISCHER fixings: Cavity fixings

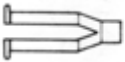

FISCHER-Hohlraum-Kunststoffdübel NA
FISCHER cavity fixings



FISCHER-Anker A
FISCHER cavity fixings



FISCHER-Nylon-Kippdübel K
FISCHER toggles



FISCHER-Hohlraum-Metalldübel HM, HM-S
 Montagezange HM Z1, HM Z2
FISCHER cavity fixings

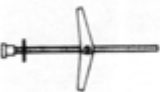

FISCHER-Feder-Klappdübel KD
FISCHER toggles



FISCHER-Metall-Kippdübel KDH, KM
FISCHER toggles

* mit bauaufsichtlicher Zulassung des DIfBT (Deutsches Institut für Bautechnik, Berlin)

Artikel-Nr.	Material	Überzug
88506	Kunststoff	
88510	Kunststoff/ Konus: Messing	
88521	Messing	
88551 88552 88553 88554	Kunststoff/ Schraube:Stahl	galZn
88558 88559	Kunststoff	
	Kunststoff/ Schraube: Messing	
	Kunststoff/ Schraube: Stahl Messing	galZn
	Kunststoff Kunststoff	galCr
	Kunststoff/ Schraube:Stahl	galZn
88502	Kunststoff	
88508	Kunststoff	
88509	Kunststoff	
88515	Stahl	galZn
88518	Stahl	galZn
88519	Stahl	galZn



FISCHER-Dübel: für Hohlräume und Leichtbaustoffe
FISCHER fixings: Cavity fixings/Lightweight material fixings



* FISCHER-Gasbeton-Dübel GB
FISCHER twist lock anchors



FISCHER-Gipskarton-Dübel GK



FISCHER-Metallspreizdübel FMD
FISCHER twist lock anchor

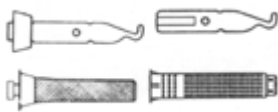

FISCHER-Injection-Anker FI M, FI P
 FISCHER-Injections-Netzanker FI M-N, FI H-N
 FISCHER-Injections-Kartuschen FIP, FIPS
 FISCHER-Injections-Innengewinde-Anker FIP-MI
FISCHER injection anchor system and accessories



FISCHER-Montageset für Injections-Dübel FI M



FISCHER-Mörtelpresse FI P



FISCHER-Injections-Mörtel FI C



FISCHER-Montageschaum PU 500



FISCHER-Dübel: für Rahmen-Befestigungen
FISCHER fixings: Frame fixings



FISCHER-Nageldübel N, N-AZ, N-FZ, N-FAL,
 N-FN/N-FC, N 6x40 M6
FISCHER nail plugs (Hammerfix)



FISCHER-Fensterrahmendübel
 F-M, F-S, S10 FS, S-FS
FISCHER fixings for frames (windows)



* FISCHER-Rahmendübel
 S-H-R, S-H-RSS, S-H-RS-Z, S-H-RT,
 S-R, S-RS-Z, S-RT, S-RSS, S-RT-F, S-RL-Z
 FISCHER-Universal-Rahmendübel FUR
FISCHER fixings for frames



FISCHER-Justierdübel S10 J 75 S
 FISCHER-Justierschraube JS
FISCHER adjusting facade fixings

* mit bauaufsichtlicher Zulassung des DIfBT (Deutsches Institut für Bautechnik, Berlin)

Artikel-Nr.	Material	Überzug
88507	Kunststoff	
(88706)	Kunststoff	
88545	Stahl	galZn
88522-88529	Stahl Kunststoff	
88569		
88576	Kunststoff	
88577		
88565		
88503	Kunststoff/ Schraube: Stahl NiroStahl A2	galZn
88516 88517	Kunststoff/ Schraube: Stahl Stahl/Stahl	galZn galZn
88505 88540- 88545 88563 88564	Kunststoff/ Schraube: Stahl NiroStahl A4	galZn
	Kunststoff/ Schraube: Stahl	galZn

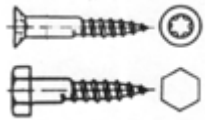

* FISCHER-Schrauben SHZ, SHT, LSZ, 6 Kt
 Senkkopf mit Pozidriv-Kreuzschlitz,
 TORX-Antrieb oder Sechskantkopf
FISCHER screws

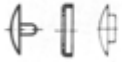

Zierkappen für FISCHER-Rahmendübel
 ADF, ADH, ADK, ADT, ADM, ASM
Caps for FISCHER fixings



FISCHER-Dübel: für Gerüste und Fassaden
FISCHER fixings: for scaffolding and facades

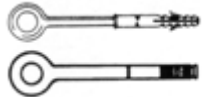

* FISCHER-Gerüsterankerungen
 S 14 ROE, GS, OES, FA-G, FI G, RI, FA 12
 Abdeckkappen für Gerüsterankerungen AD 12
FISCHER fixings for scaffolding



FISCHER-Dämmstoff-Befestigungen
 DHK, DHM, DTM, DHN, DT
FISCHER fixings for insulating material



FISCHER-Dämmputz-Befestigung DP
FISCHER fixings for insulating material

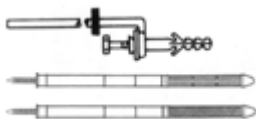

FISCHER-Verblendanker VB
 FISCHER-Verblendsanieranker VBS, VBS-N
 Montage-Werkzeuge
FISCHER wall anchors



* FISCHER-Vorspannkonsolen FVK
FISCHER fixings for facades



FISCHER-Dübel: für schwere Lasten
FISCHER heavy-duty fixings



* FISCHER-Schwerlast-Dübel SL M/SL M-N
FISCHER expansion units



FISCHER-Mauerschrauben MR
FISCHER steel anchors

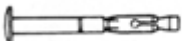

* FISCHER-Nagel-Anker FNA, FNA M, FNA OE, FNA H
FISCHER nail anchors



* FISCHER-Automatic-Stahldübel FA, FAC
FISCHER automatic-steel anchors





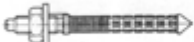

FISCHER-Reaktionsanker RM
 Ankerstangen RGM
 FISCHER-Combi-Reaktionsanker FCR-A
FISCHER chemical anchor systems (capsules and studs)



Artikel-Nr.	Material	Überzug
88596 88597 88598 88599	Stahl NiroStahl A4	galZn
88501 88556 88557	Kunststoff	
88536 88537 88538	Kunststoff Stahl	galZn
88514 88580	Kunststoff Stahl	Al-Zn- Auflage
	Kunststoff	
88555 88556 88581 88586 88590- 88594	Kunststoff NiroStahl A4	
88554	NiroStahl A2	
88530	Stahl NiroStahl A4	galZn
88531	Stahl	galZn
88546 88547 88548 88549	Stahl	galZn
88532	Stahl NiroStahl A4	galZn K-Mantel
88533 88534 88535 88539	Glaspatrone Stahl NiroStahl A4	galZn

* mit bauaufsichtlicher Zulassung des DIfBT (Deutsches Institut für Bautechnik, Berlin)

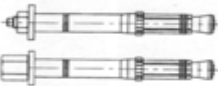
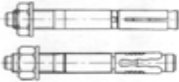





-  * FISCHER-Einschlaganker EA
 Setzwerkzeuge
FISCHER expansion anchors and tools
-  * FISCHER-Bolzen FB, FB-S
FISCHER bolt anchors
-  * FISCHER-Hochleistungs-Anker FHA-B, FHA-H
FISCHER heavy-duty anchor
-  * FISCHER-Ankerbolzen FAB, FAN
FISCHER bolt anchors
-  * FISCHER-Zykon-Anker FZA, FZA-D, FZA-I,
 FISCHER-Zykon-Einschlag-Anker FZEA
 Bohrer, Setzwerkzeuge
FISCHER anchors Zykon, drills, tools

Dübel und Anker

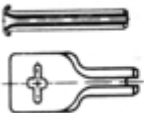
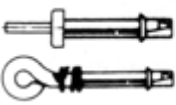

Upat-Dübel: Allgemeine Befestigungen *Upat fixings: General fixings*

-  Upat-Normdübel N
Upat wall plugs
-  Upat-Dübel U, UL
 Upat-Universal-Dübel UVD, UVD-K
Upat wall plugs
-  Upat-Nageldübel UN-M, UN-PK, UN-SK, UN-ZK, UN-T
 Upat-Zinknagel-Dübel UZN
Upat nail plugs, Upat zinc nail plug
-  Upat-Express-Nagel EXN
 Abdeckkappen für EXN
 Upat-Expreß-Laschen EXL-RL-LL
Upat suspension nails, anchors, caps
-  Upat-Deckennagel DN
 Upat-Springöse US-Ö
Upat safety nails, spring anchors
-  Upat-Messing-Dübel MS
 Upat-Metric-Dübel MT
Upat brass plugs

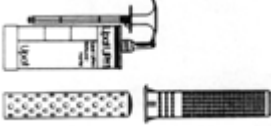

Upat-Dübel: für Hohlräume und Leichtbaustoffe *Cavity fixings and light weight material fixings*

-  Upat-Turbo-Leichtbau-Anker K, M
 Upat-Gipskarton-Dübel TURBOLET TL
Upat non-expanding anchors, tools
-  * Upat-Verbundmörtel UPM 1, UPM 33
 Upat-Siebhülse UPM-SH
 Upat-Einschraubhülse UPM-EH
Upat chemical anchor systems
Upat perforated capsules

Artikel-Nr.	Material	Überzug
88567 88568	Stahl NiroStahl A4	galZn
88570	Stahl NiroStahl A4	galZn feuerZn
88578 88598	Stahl NiroStahl A4	galZn
88550 88579	Stahl	galZn
88583- 88597	Stahl NiroStahl A4	galZn
88700	Stahl/ Hanfeinlage	alu- minium- plattiert
88701 88709	Kunststoff	
88704	Kunststoff/ Schraube: Stahl NiroStahl A2 Zink/ Nagel: Stahl	galZn
88705	Stahl	galZn
	Stahl	galZn
88708	Messing Messing	
88702 88703 88706	Kunststoff Zink-Spritzguß	
88733 88735 88749	Stahl Kunststoff	galZn

* mit bauaufsichtlicher Zulassung des DIFBT (Deutsches Institut für Bautechnik, Berlin)



Upat-Dübel: Befestigungen für Rahmen und Fassaden

Upat fixings: Special fixings for frames, caps



Metall-Rahmendübel MeKD (TOGE)
Abdeck-Kappen
Metal fixings for frames, caps



Upat-Blendrahmendübel URS,
Abdeckkappen
Upat fixings for frames, caps



* Upat-Fassadendübel UR-Z, ULR
Upat fixings for facings



Upat-Isolierplatten-Dübel IPS, U-ID
Upat-Isoliermatten-Dübel IMD
Spreiznägel IMD, ISO-Scheiben
Upat-Dämmputz-Krallen UD
* *Upat fixings for insulating material*

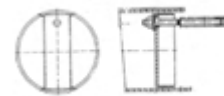

* Upat-Vorspann-Konsolen DSP
Upat fixings for facades



Upat-Dübel: für schwere Lasten

Upat fixings: Heavy duty fixings

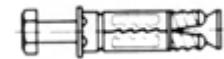

Upat-Anker UTA-L
mit Sechskantschraube u. Scheibe
Rawl plugs with hexagon head bolt and washer



Upat-Anker UTA-P
mit Keilbolzen, Mutter und Scheibe
Rawl plugs with cone end bolt, nut, washer



Upat-Ankerschalen UTA-S
Upat-Duplex-Anker
Rawl shells, Duplex anchors

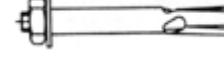

Upat-Hülsen-Anker UHA-B, UHA-S
Upat sleeves anchors

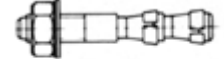

* Upat-Express-Anker EXA/EXA kurz /MAX
Upat-Monoclip-Anker MC
Upat express anchors, Upat-clip-anchors

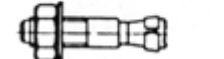

* Upat-Schlaganker USA,
Setzwerkzeuge, Ausbläser
Upat expansion anchors, tools

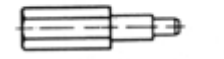

* Upat-Verbundanker-Patronen UKA 3 EAP
Upat-Einschlagpatrone UES für Betonstahl
* Upat-multicone-Verbundanker-Patronen UMV-P
Upat chemical anchor systems (capsules)



Artikel-Nr.	Material	Überzug
88650	Stahl Kunststoff	galZn
	Kunststoff/ Schraube:Stahl	galZn
88707	Kunststoff/ Schraube: Stahl NiroStahl A4	galZn
	Kunststoff Stahl	galZn
	Stahl NiroStahl A4	feuerZn
88710	Temperguß/ Schraube: Stahl	galZn
88711	Temperguß/ Schraube: Stahl	galZn
88712	Temperguß	
88713	Stahl	galZn
88715	Stahl NiroStahl A4	galZn
88716 88717 88718 88719	Stahl NiroStahl A4	galZn
88720 88721 88740 88757	Glaspatronen	

* mit bauaufsichtlicher Zulassung des DIFBT (Deutsches Institut für Bautechnik, Berlin)



- * Upat-Ankerstangen für UKA 3/UPM 33
Innengewindehülsen IST
- * Upat-multicone-Verbundanker-Stangen UMW
und Setzwerkzeuge
- * Upat-Leitplankenanker UKA3_EAP-LA
Upat studs for UKA 3/UPM 33

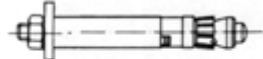
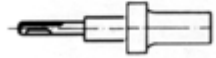

- * Upat-Hinterschneid-Anker TOP-D, TOP-H, TOP-V
Bohrer, Setzwerkzeuge
Upat TOP-anchors, drills, tools

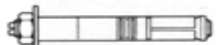

- Upat-Anker PSA
- * Upat-Anker PSZ-B, PSZ-S, PSZ-SK
Upat PS-anchors

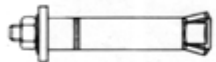

- * Upat-Schnellmontage-Anker SM-H, SM-V
mit selbsterzeugtem Hinterschnitt,
V = mit Gewindebolzen (Vorsteckanker),
H = mit Innengewinde
Bundbohrer, Setzwerkzeuge
Upat anchors-system SM

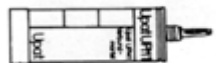
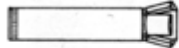

- * Upat-Verbundmörtel UPM 1, UPM 33
Upat chemical anchor system



Einspritzpistolen für Upat-Verbundmörtel UPM
Tools for Upat UPM

Dübel und Anker

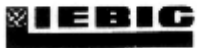

LIEBIG-Dübel

LIEBIG anchors and fixings

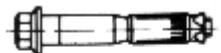

- * LIEBIG-Sicherheitsdübel B, S, SK
LIEBIG safety bolts

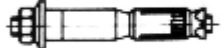

- * LIEBIG-Hinterschnitt-Schlaganker
super plus LSP-A, LSP-D, LSP-I
Bundbohrer BB, Einschlagwerkzeug EW
LIEBIG anchors, drills, tools

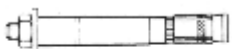

- * LIEBIG-Bolzenanker, BoA-G, BoA-H, BoA-K
LIEBIG bolt anchors with nut and washer

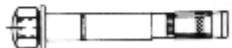

* mit bauaufsichtlicher Zulassung des DIFBT (Deutsches Institut für Bautechnik, Berlin)

Artikel-Nr.	Material	Überzug
88714 88722- 88724 88734 88758 88759	Stahl NiroStahl A4	galZn feuerZn
88725- 88732	Stahl NiroStahl A4	galZn
88742 88743	Stahl NiroStahl A4	galZn
88753- 88756	Stahl NiroStahl A4	galZn
88733		
88736	Stahl	galZn
88600 88601 88602	Stahl NiroStahl A4	galZn
88636- 88640	Stahl NiroStahl A4	galZn
88604 88606 88606	Stahl NiroStahl A4	galZn



* LIEBIG-Einspannanker Ultra plus
LIEBIG safety anchors ultra plus



LIEBIG-Hinterschneidwerkzeuge
 für Ultra-plus-Anker
Special drills for LIEBIG safety anchor ultra plus

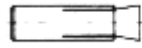

LIEBIG-Anker Typ A
 Sprezhülsen mit Gewindekonus
LIEBIG anchors type A (expansion sleeves with cone)



LIEBIG-Klebeanker KLP
 Ankerstangen für KLP
LIEBIG chemical anchor systems (capsules and studs)



LIEBIG-Schnellspann-Setzwerkzeug
 für Ankerstangen
LIEBIG special chuck for rods



* LIEBIG-ultraplus-Hinterschnitt-Klebeanker
 LIEBIG-Ankerstangen
LIEBIG chemical safety anchors

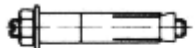

* LIEBIG-Anker AB, AS
LIEBIG anchors



LIEBIG-Messingspreizdübel WECO
 mit Spreitzreibeinlagen
LIEBIG brass plugs



LIEBIG-Sechskant-Gewindemuffen
LIEBIG hexagon screw sockets

Bohrtechnik
Drill technique

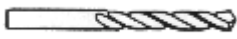

HSS-Spiralbohrer DIN 338 für Stahl
 HSS-ECO-Spiralbohrer für Sonderwerkstoffe
Drill for steel and special materials



Steinbohrer/Schlagbohrer ~ DIN 8039
 Standard- und Sonderlängen
Masonry drills



Hammerbohrer ~ DIN 8035
 mit SDS-plus-Schaft,
 Nuten-, Konus-, Sechskantschaft
Concrete drills



Schnellspann-Setzwerkzeuge für Ankerstangen
Special chuck (for chemical anchor systems)

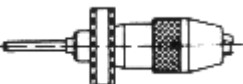

Artikel-Nr.	Material	Überzug
88607	Stahl NiroStahl A4	galZn
88612	Stahl NiroStahl A4	galZn
88614 88615	Glaspatrone Stahl NiroStahl A4	galZn
88984	Stahl gehärtet	
88616 88617	Stahl NiroStahl A4	galZn
88623	Messing	
88630	Stahl	galZn
88988 88989	Stahl gehärtet	
88990 88991	Stahl gehärtet	
88997	Stahl gehärtet	
88984 88985	Stahl gehärtet	

* mit bauaufsichtlicher Zulassung des DIFBT (Deutsches Institut für Bautechnik, Berlin)



Schraubtechnik
Fastening technique



Universalhalter, Schraubkupplungen, Magnethalter
Bit holders, screw couplings



Steckschlüssel
Sockets



Schraubklingen mit Sechskantantrieb für Schrauben mit Längsschlitz, Kreuzschlitz (Phillips, Pozidriv) und TORX/Innensechsrund/Innenstern
Bits for bolts and screws with slot, cross recess, TORX



Schraubklingen-Sortimente
 - für Längsschlitz
 - für Kreuzschlitz H, Z
 - für TORX / Innensechsrund
Boxed assortments bits



Blindniet-Technik

Blindniete DIN 7337
 Form A = Flachkopf
 Form B = Senkkopf
Blindrivets DIN 7337
 A = flat head, B = countersunk head



* Spezial-Blindniete mit großem Setzkopf
 Spezial-Blindniete für Fassaden
Special blind rivets with large head



Spezial-Blindniete mit gerilltem Schaft
Special blind rivets with grooved shaft



"CAP"-Blindniete für luft- und wasserdichte Verbindungen
"CAP"-blind rivets for air and water tight connections

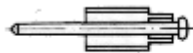

Spezial-Blindniete mit Anschlußgewinde
Special blind rivets with threaded pin



Spezial-Blindniete mit Klemmprofilkopf
Special blind rivets with swaged head

Artikel-Nr.	Material	Überzug
88279 88280	Stahl gehärtet	
88265	Stahl gehärtet	
88655- 88662	Stahl gehärtet	
88281- 88286		
88401- 88417	Stahl Al-Leg NiroStahl A2, A4	galZn eloxiert
88411 88412	Kupfer NiCu Kunststoff	
88413 88414	Stahl Al-Leg	galZn Köpfe lackiert
88419	Al-Leg	
88420	Al-Leg	
88421	Stahl Al-Leg	galZn
	Al-Leg	

* mit bauaufsichtlicher Zulassung des DIFBT (Deutsches Institut für Bautechnik, Berlin)



Spreiz-Blindniete/Bulbtite®-Blindniete
 für Montagen an weichen Baustoffen
Expansion blind rivets/Bulb-tite® blind rivets

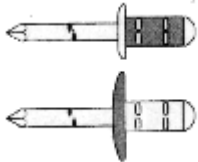

Mehrbereichs-Blindniete
 GESIPA-Poly Grip®
 Form A = Flachkopf
 Form FK = großer Flachkopf
Special blind rivets GESIPA-Poly Grip®



Blindniet-Muttern
 F = Flachkopf, S = Senkkopf, SK = kleiner Senkkopf
Blind rivet nuts
 F = flat head, S = countersunk head, SK = small countersunk head

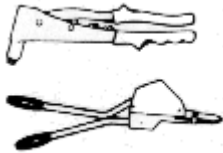

Handzangen für Blindniete und Blindnietmuttern
Handtools for blind rivets and blind rivet nuts

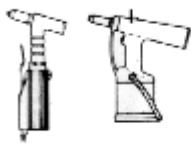

Nietpistolen für Blindniete und Blindnietmuttern
Automatic tools for blind rivets and blind rivet nuts

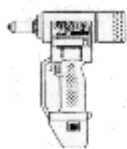

GESIPA-AccuBird/GESIPA-FireBird:
 Kabellose Setzpistolen
 für Blindniete/Blindnietmuttern
Accu tool for blind rivets/blind rivet nuts

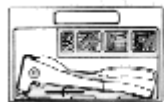

GESIPA-automatic GAV
 Vollautomatische Blindnietanlage
 für industrielle Serienfertigung

Nietboxen, Sortimentskästen, Montagekoffer
Boxed assortments and assembly chests

* mit bauaufsichtlicher Zulassung des DIfBT (Deutsches Institut für Bautechnik, Berlin)

Artikel-Nr.	Material	Überzug
88422	Stahl Al-Leg NiCu NiroStahl	galZn
88474 88475	Al-Leg	
88418- 88424	Stahl Al-Leg	galZn
88430- 88440		
88425- 88445		
88455 88456 88457 88465		
30430- 30449		